



ALUMINUM
Railing Systems
Lifetime Warranty



 **Key-Link**
Fencing & Kennels, LLC
Quality, Our Key Link To Serving You!
 150 Orlan Road • New Holland, PA 17557
 800-633-7093 • Fax: 717-355-7139

 *Arabian*
 SERIES

Aluminum Railing Systems

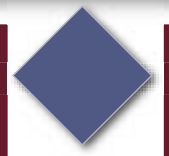

Secondary Handrail



Offering exceptional versatility, the Arabian Series is unique, heavy wall, extruded aluminum railing sold in boxed sections.

Currently available in 36" and 42" heights, and 6' and 8' lengths in powder coated Black, White and Bronze, the Arabian has a full complement of easy to install brackets offering both straight and 32° to 36° step railing applications.

LIFETIME WARRANTY

Railing Profiles



Unique full length PVC inserts in both the top and bottom rails allow a faster, "screwless" assembly and create a tight, quiet fit.

Top Rail

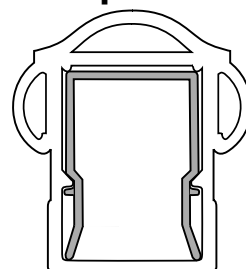

1 3/4" x 1 7/8"

Bottom Rail

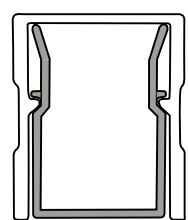

1 1/4" x 1 1/2"

Drains in the bottom rail allow any moisture to escape.

Lifetime Warranty

All Arabian™ railing, posts, brackets, and connectors are warranted against failure of either the materials used, or the manufacturing process, for life. This warranty does not include slight changes in coloration due to a natural aging process. It also does not include any damage or failure due to misuse or abuse.

All Arabian™ Railing Sections are tested in accordance with the IBC 2003, International Building Code® and the IRC 2003, International Residential Code®.

Table of Contents

Portland Structural Porch Post	3
Arabian Railing Options	3
Somerset 6' & 8' Railing	4
Richmond 6' & 8' Railing	5
Trenton 6' & 8' Railing	6
Hampton 6' & 8' Railing	7
Dayton 6' & 8' Railing	8
Brackets	9
Arabian Accessories	9
Round & Decorative Secondary Handrail	10
Gates & Hardware	11

Portland

STRUCTURAL AND HOLLOW PORCH POST



3 1/4" x 3 1/4" x 108"
Structural post - maximum load: 7,500 lbs. uplift: 1,170 lbs.
Hollow post - maximum load: 5,000 lbs. uplift: 1,365 lbs.



Custom radiuses can be fabricated for your specifications.

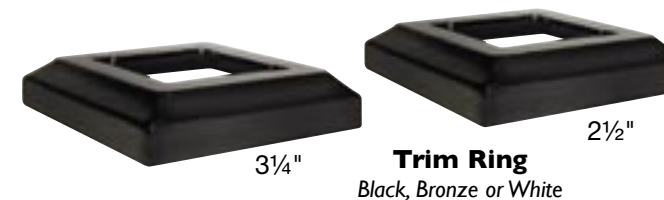

3 1/4"

Trim Ring
Black, Bronze or White

2 1/2"

Newel Post Options



2 1/2"

3 1/4"

Baluster Options



Somerset

Richmond

Trenton

Hampton

Dayton

Post Cap Options



3 1/4"



2 1/2"

FLAT
(Standard)



3 1/4"



2 1/2"

BALL
(Optional)

Boxed Railing Sections

Boxed Railing Sections Include:

- Top rail, bottom rail, balusters, mounting brackets and hardware.
- Brackets to mount on straight runs and step railing are included.
- Comes in 6', 8' sections, 36" or 42" high.
- Also available in 6' and 8' step sections (32° or 36°).
- Installation instructions included.

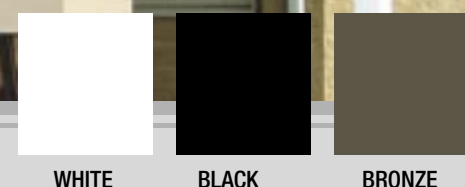
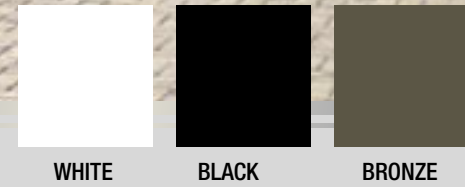

Somers set
6' AND 8' LEVEL & STAIR RAILING



Picket Profile
Square



Richmond
6' AND 8' LEVEL & STAIR RAILING

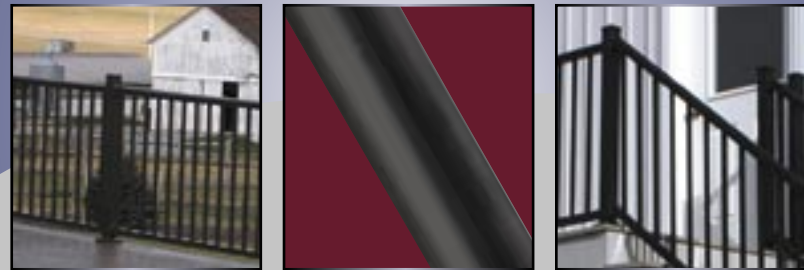

Picket Profile
Round

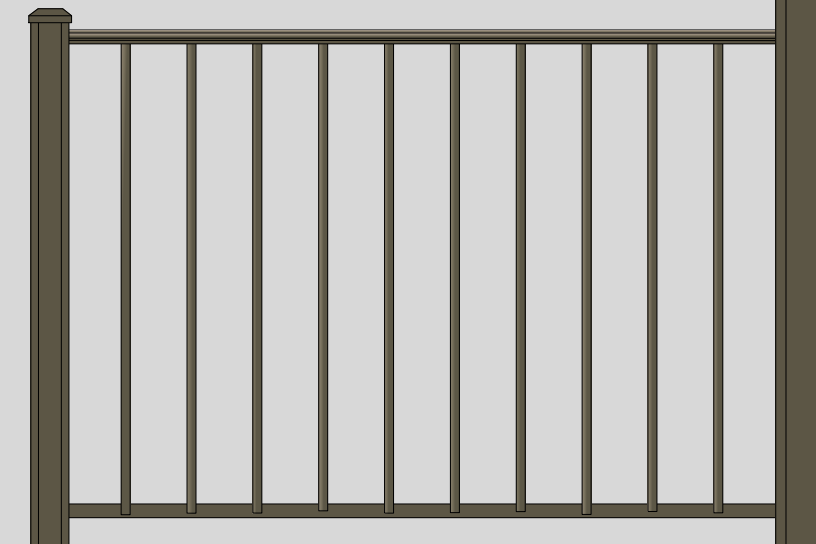

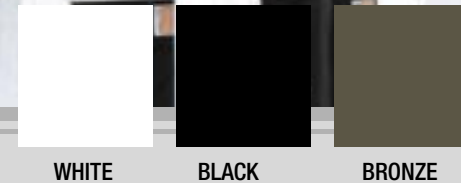
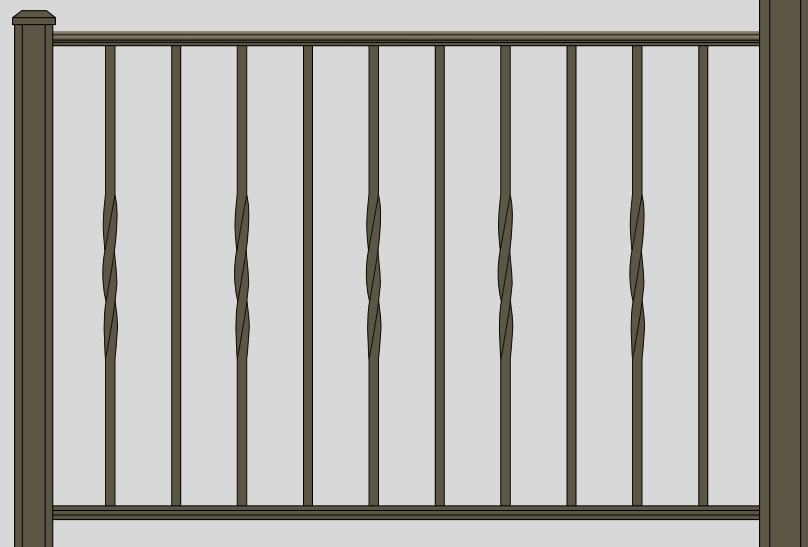
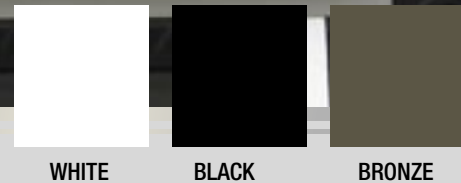

Trenton

6' AND 8' LEVEL & STAIR RAILING

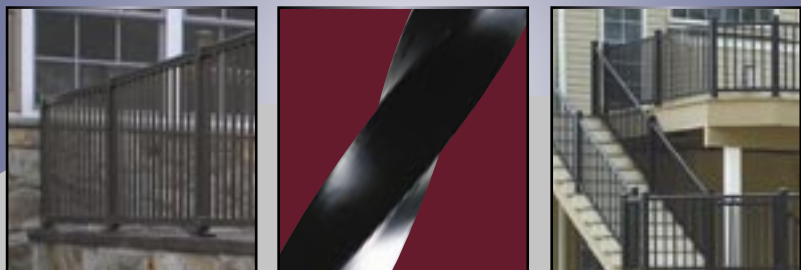

Picket Profile
Alternate Square & Twisted

Hampton

6' AND 8' LEVEL & STAIR RAILING

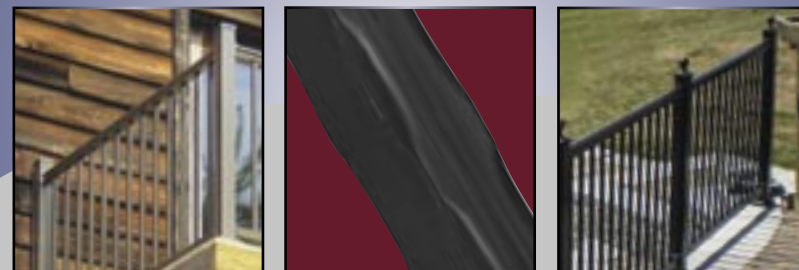

Picket Profile
Alternate Square & Hammered

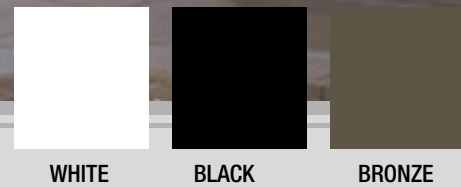

Brackets

FRACKET & ACCESSORIES



Brackets are available for not only straight and 32° to 36° step sections, but 45° corners, 22½° angle, swivel mounts and unusual step installations as well.



22½° Top & Bottom Brackets
set of 4 (2 each)



Swivel Top & Bottom Brackets
set of 4 (2 each)



Straight Top & Bottom Brackets
set of 4 (2 each)



Universal (Any Degree) Step Brackets
set of 4



For 2½" post only!
45° Top & Bottom Bracket Adaptors
set of 4 (2 each)



32° to 36° Step Top & Bottom Brackets
set of 4 (2 each)

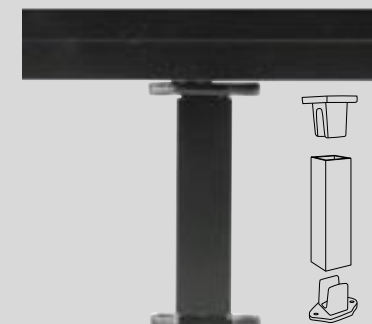

Railing Section Support



**Spray Paint Can
Spray Paint Pen**
Black, Bronze or White



Fracket
All Stainless Steel Post Bracket
An all stainless steel heavy-duty post bracket facilitates installations on almost any surface, especially concrete, when properly installed.
2½" or 3¼"

Dayton

6' AND 8' LEVEL & STAIR RAILING

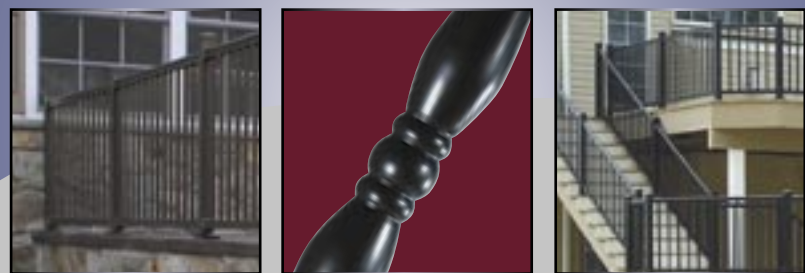

Picket Profile
Alternate Square & Decorative

Secondary Handrail

ROUND & DECORATIVE HANDRAIL

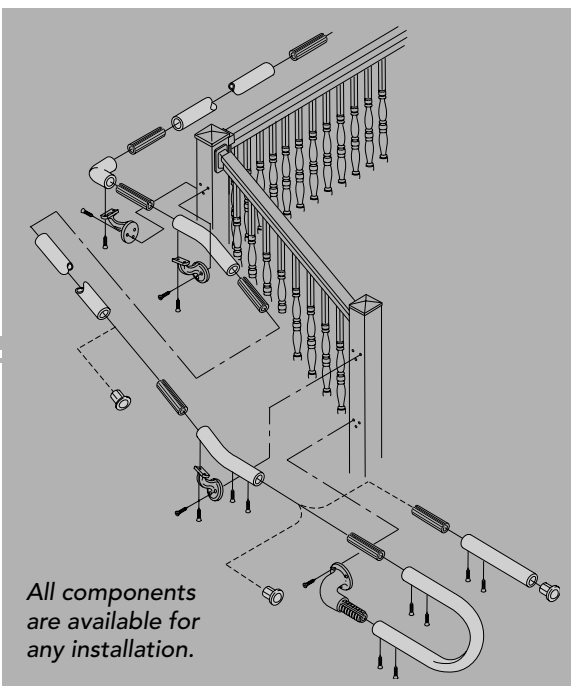

Gates & Hardware

